

Schnitt A-A Schnitt B-B

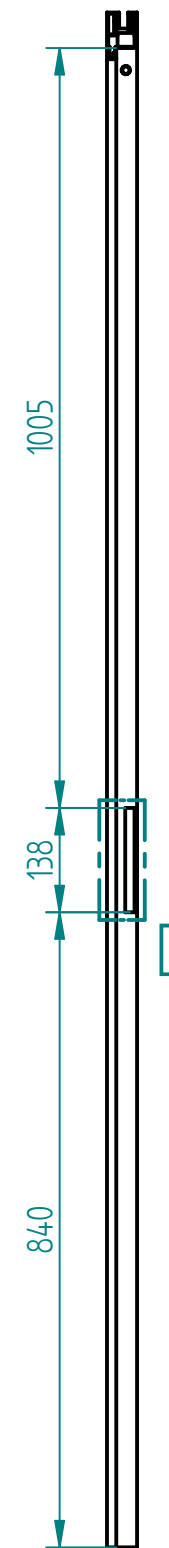

EINZELHEIT C 1:1

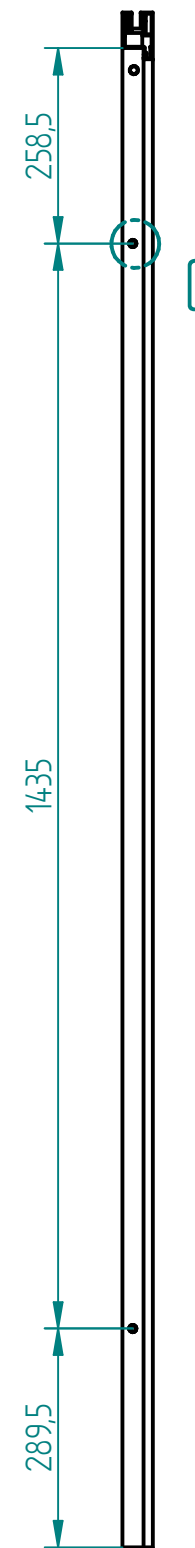
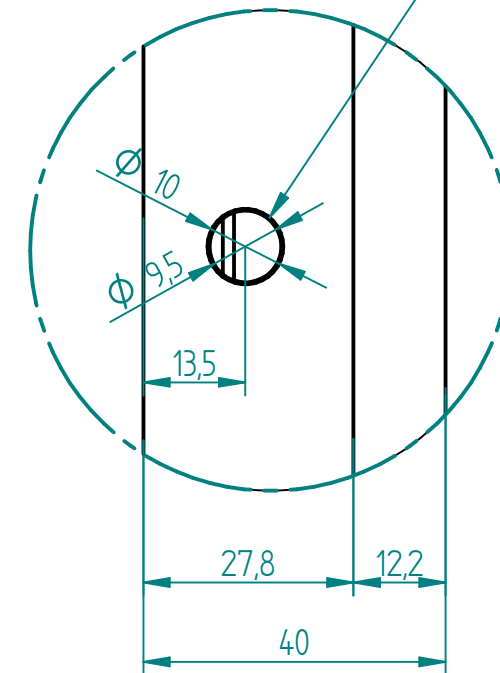

EINZELHEIT D 1:2

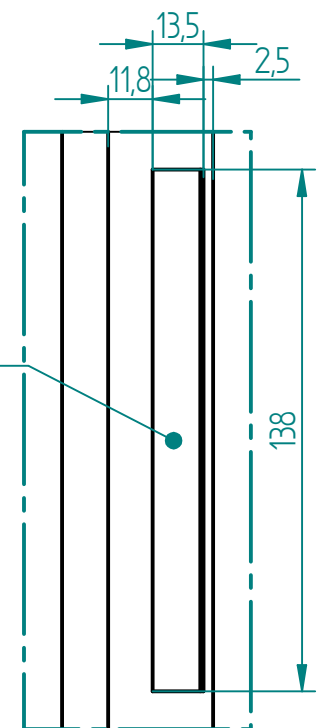

EINZELHEIT E 1:2

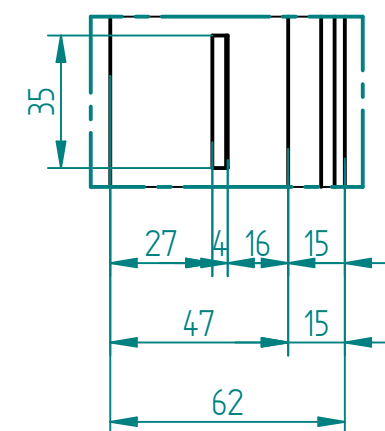

	NAME	DATE		
gezeichnet	Technik	14.01.2016		
geprüft			Stückzahl	
Oberfl. Beschläge	K240		SIZE Benennung:	
Glasart			A3	Türzarge DIN-Links 834 x 1972
Glasstärke			FILE NAME: Türzarge_DIN-L_834x1972.dft	
Kanten			SCALE: M 1:10 WEIGHT:	
Oberfläche Glas			REV	