

Schnitt A-A Schnitt B-B

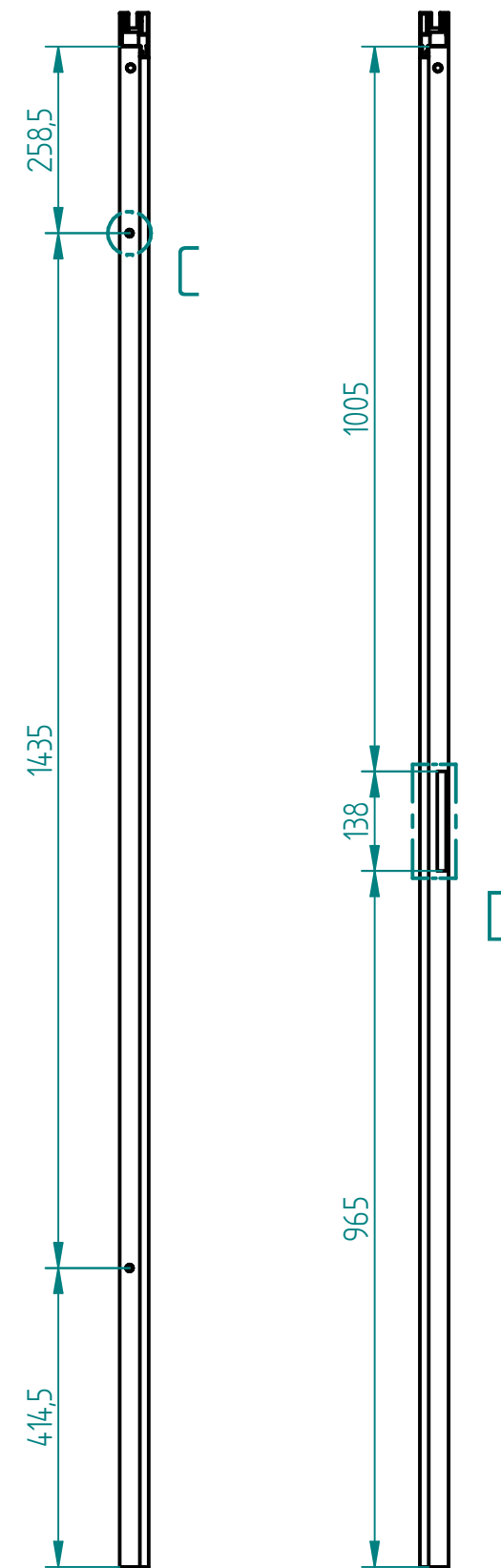

EINZELHEIT C
1:1

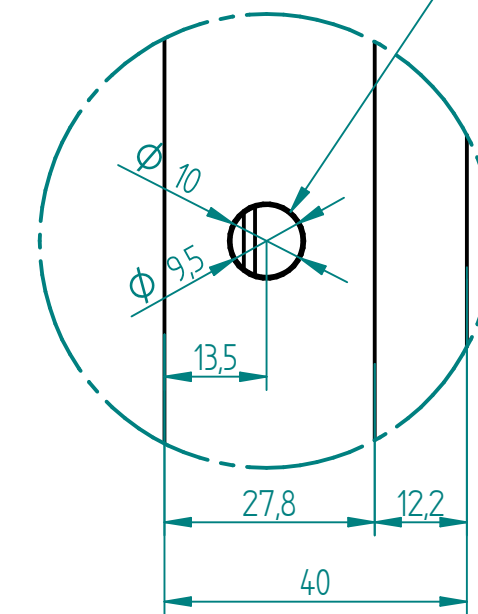

EINZELHEIT D
1:2

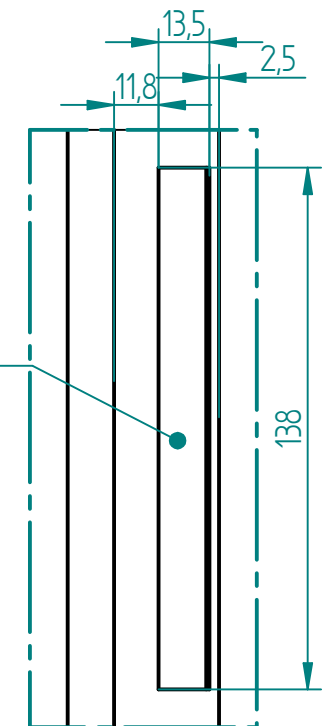

EINZELHEIT E
1:2

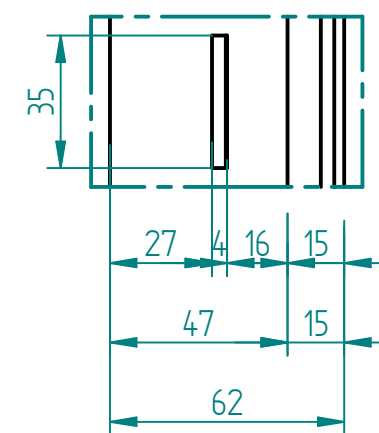

	NAME	DATE		
gezeichnet	Technik	14.01.2016		
geprüft			Kunde:	
Oberfl. Beschläge	K240			
Stückzahl				
Glasart			SIZE	Benennung:
Glasstärke			A3	Türzarge DIN-Links 709 x 2097
Kanten			FILE NAME: Türzarge_DIN-L_709x2097.dft	
Oberfläche Glas			SCALE: M 1:10	WEIGHT: